

niro



1920-2020

100
JAHRE
FRIEDRICH MÜNCH

PROTECTION GLOVES
MAIN CATALOG

WWW.NIRO-S.DE/EN

2023



Friedrich Münch GmbH + Co KG
In den Waldäckern 10
75417 Mühlacker
Germany

Telephone: +49 (0) 7041 9544-0
Telefax: +49 (0) 7041 9544-55
E-Mail: info@niro-s.de
Web: www.niro-s.de/en

TABLE OF CONTENTS

CATALOG

Friedrich Münch GmbH + Co KG	4
Brand world Friedrich Münch	6
Coating and guidelines	14
Assembly and multipurpose gloves	22
Polyurethan Coating	24
Nitrile foam Coating	28
NIRO-S tec-Coating	32
Latex Coating	33
Nitrile Coating	36
Cut protection gloves	40
Cut protection class 3/B	42
Cut protection class 5/C	46
Cut protection class 5/D	48
Cut protection class F	50
ESD gloves	56
Winter gloves	62
Protective sleeves	68



PROTECTING



100 YEARS

Friedrich Münch GmbH + Co KG will be 100 years old in 2020. Since 1920, Mühlacker has been the headquarters of the family-run company, which, with its ability to innovate and the diligence of its employees, is one of the market leaders worldwide and is synonymous with safety.

250 EMPLOYEES

250 highly qualified employees work for the niroflex and NIRO-S brands.

50 YEARS

50 years last some of the longest partnerships with the trade. That creates trust.

70 COUNTRIES

Friedrich Münch GmbH + Co KG supplies its products for more safety to more than 70 countries.

1920-2020

100
YEARS

FRIEDRICH MÜNCH

Best then.
Better now.

HANDS.

THE RIGHT GLOVE FOR SURE

The niroflex and NIRO-S brands are the best choice in over 70 countries when it comes to protecting hands at work. Prick protection and cut protection combined with great wearing comfort characterize the protective gloves without being a hindrance – even during delicate work.

INNOVATIVE AND GROUNDBREAKING

In the field of safety products, Friedrich Münch GmbH + Co KG sets new benchmarks in innovation, technology and quality decade after decade. The products in this catalog prove it – see for yourself.





NIRO-S – EXCELLENT PROTECTIVE GLOVES

The brand name NIRO-S stands for premium protective gloves and safe working in industrial applications. The performance portfolio of NIRO-S gloves ranges from assembly work to work with sharp-edged tools or electrostatic objects.

In NIRO-S, Friedrich Münch GmbH + Co KG bundles its know-how and expertise as one of the world's leading manufacturers of personal protective equipment for everyday work.

But it is not the company alone that is responsible for the success of the young NIRO-S brand. It is the people who work for NIRO-S. From purchasing to quality control and sales to warehouse, logistics and shipping, their goal is to make the product behind the brand better so that working is safer.



THINK SAFE.



RING MESH GLOVES & APRONS

In 1968, Friedrich Münch GmbH + Co KG introduced the world's first stab protection glove made of welded stainless steel ring mesh. To this day, niroflex brand products are synonymous worldwide with safety products in the food processing industry – "Quality – Made in Germany".

The breadth of our product range and our high vertical range of manufacture enable us to respond individually to the requirements of our customers and the needs of users. Our gloves, aprons or customized protective clothing show their high functionality in many intelligent details, all of which have only one goal: **to optimally protect the person wearing them.**

**STAINLESS STEEL
RING MESH**









niroflex
premium protection

BLUECUT / WHITECUT

Parallel to the development of our ring mesh gloves, a diversified range of high-quality cut protection gloves was also created under the niroflex brand. Knitted niroflex cut protection gloves for handling groceries have long exceeded the maximum values required by EN 388:2016 and offer the highest quality for greater safety.

**CUT PROTECTION
GLOVES**

niroflex

premium protection

BODYARMOR

In 1990, Friedrich Münch GmbH + Co KG developed the first ring mesh stab protection inserts for ballistic vests. Today, the company supplies customized solutions worldwide, also for individual fabrications. The claim to "100% quality" is indispensable in this area.

All over the world, niroflex ring meshes are used in protective vests and clothing for the police, military and civilian security forces.





SAFETY FOR POLICE AND MILITARY





QUALITY, COATING, STANDARDS AND PROTECTION

NIRO-S TEC-COATING

The NIRO-S tec-coating is currently one of the most innovative and high-performance glove coatings. In several comparative tests, the NIRO-S tec coating was able to prove its superiority. The NIRO-S tec coating is a double-dipped coating based on nitrile foam and is probably the thinnest coating available on the market.



NIRO-S TEC IN DETAIL

1. Double-dipped nitrile foam-based coating.
2. Ultra-thin.
3. Oil-repellent.
4. The significantly reduced coating cross-section enables gloves with extremely good touch sensitivity.
5. The significantly thinner NIRO-S tec gloves have a truly exceptional fit.
6. The double-dipped coating makes NIRO-S tec gloves abrasion-resistant and extremely durable.
7. NIRO-S tec gloves are currently available in four variants.

NIRO-S TEC VARIANTS

NIRO-S tec #1024

Ultra-comfortable 18 gauge liner, palm and fingertips, coated

NIRO-S tec #1025

Comfortable 15 gauge liner, 3/4 coated

NIRO-S tec #3007

Ultra-comfortable 18 gauge HPPE liner, palm and fingertips coated, cut protection class 3

OVERVIEW COATING

POLYURETHANE (PU)



Polyurethane (PU) coatings are particularly sensitive, very elastic and adapt to the movements of the hand. The microporous coating is permeable to air and ensures that the glove is ventilated. PU does not react to cold or heat, so the glove always adapts to the hand. PU is hard-wearing and durable.

NITRILE



Nitrile coatings are mechanically durable, highly abrasion resistant and impervious to liquids. As a coating, nitrile is ideal for protecting the hand from chemicals, solvents, oils and greases. Nitrile coatings are also very durable, have high resistance and are very elastic in handling.

LATEX



Latex coatings are characterized by a very high flexibility. They are very resistant to mechanical impact. The soft, elastic coatings are robust, insensitive to water, resistant to oils. Latex provides a very good grip even on damp or wet surfaces.

LATEX FOAM

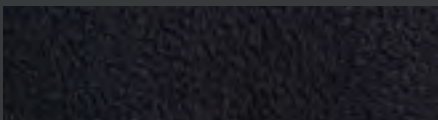

Latex foam coatings are highly elastic. Latex foam provides an excellent grip in both dry and wet environments. The microporous structure makes the glove soft and ensures a good fit. Latex foam is also extremely abrasion resistant.

NITRILE FOAM



Nitrile foam coatings are particularly non-slip in damp environments or on slightly oily surfaces. Nitrile foam coatings are soft, give mobility and very good tactile sensitivity. The open-pored structure conducts heat and moisture to the outside and is very abrasion-resistant.

NFT-NITRILE FOAM



NFT (New Foam Technology) coatings are characterized by their lightness, good breathability and high flexibility. The microporous structure allows heat to be transported to the outside and reduces sweating inside the glove.

MICRO NITRILE FOAM

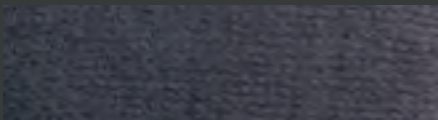

Micro nitrile foam coatings can be dipped extremely thin. The characteristic properties of nitrile foam – high breathability, good grip – are retained. Fit and wearing comfort are significantly improved.



PROTECTION GLOVES STANDARDS AND GUIDELINES

GENERAL REQUIREMENTS FOR GLOVES: EN 21420

Standards and guidelines are an essential factor in the production of protective gloves. The EN 420 standard specifies the relevant test methods and general requirements to be applied to all protective gloves. These include design principles, glove manufacture, resistance of the glove material to water penetration, harmlessness, comfort and performance, as well as the labeling and information to be provided by the manufacturer.



EN 388:2003

MECHANICAL RISKS

Abrasion resistance (0 - 4)
Cut resistance (0 - 5)
Tear resistance (0 - 4)
Puncture resistance (0 - 4)



EN 388:2016

MECHANICAL RISKS

Abrasion resistance (0 - 4)
Cut resistance (0 - 5)
Tear resistance (0 - 4)
Puncture resistance (0 - 4)
Cut resistance (A - F)

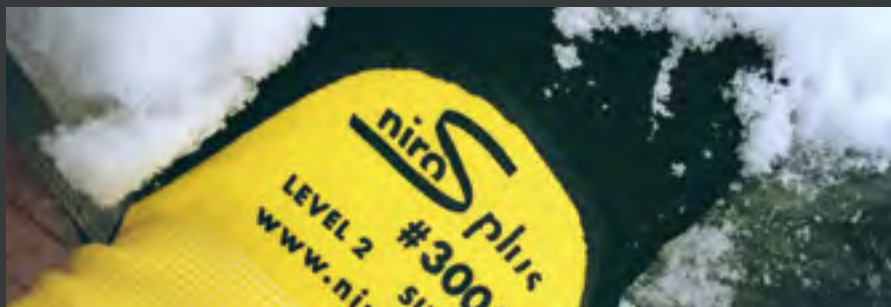

EN 511

COLD

Convective cold (0 - 4)
Contact cold (0 - 4)
Water permeability (0 - 1)

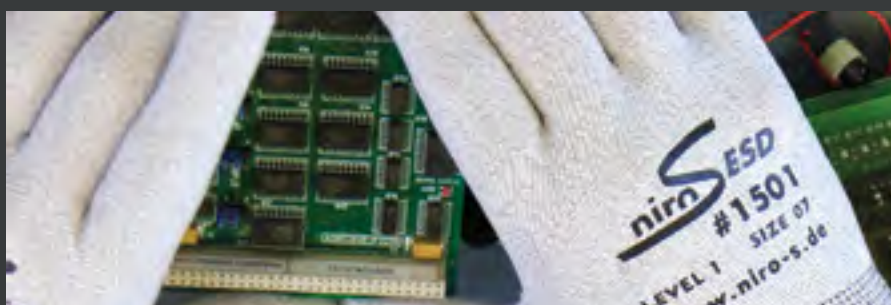

EN 16350:2014

Electrostatic properties of safety gloves

**PROTECTION AGAINST
MECHANICAL RISKS:
EN 388:2003**

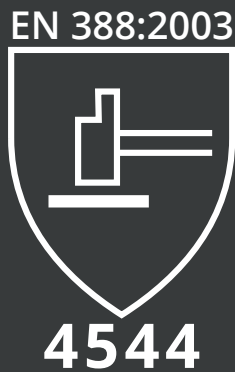

Protective gloves against mechanical risks bear the pictogram of the standard. The performance levels of the test must be listed in the following order:

ABRASION RESISTANCE (0 - 4)

Number of test cycles that are necessary to wear through the test glove.

CUT RESISTANCE (0 - 5)

Number of test cycles required at constant speed until the test glove is cut through.

TEAR RESISTANCE (0 - 4)

Force required to tear the test glove.

PUNCTURE RESISTANCE (0 - 4)

Force necessary to pierce the test glove with a standardized tip.

CUT RESISTANCE ACCORDING TO COUP-TEST EN 388:2003

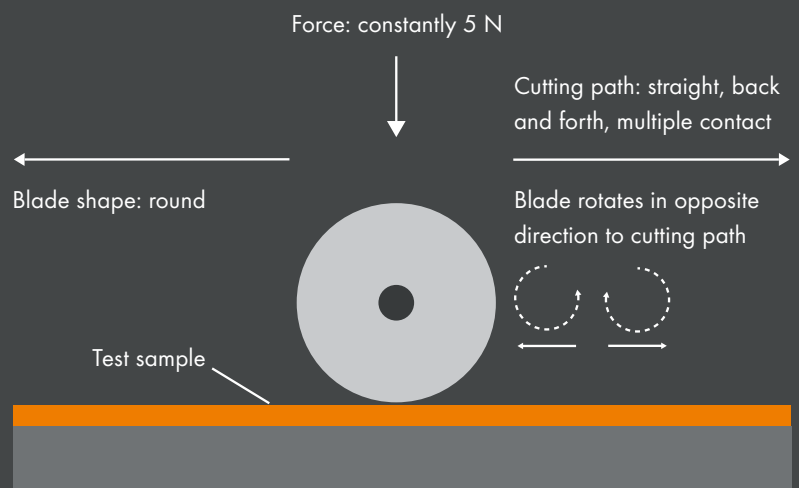

	0	1	2	3	4	5
Abrasion resistance (cycles)	< 100	100	500	2000	8000	–
Cut resistance (factor)	< 1,2	1,2	2,5	5	10	20
Tear resistance (Newton)	< 10	10	25	50	75	–
Puncture resistance (Newton)	< 20	20	60	100	150	–

PROTECTION GLOVES STANDARDS AND GUIDELINES

CUT RESISTANCE TDM / EN ISO 13997; EN 388:2016

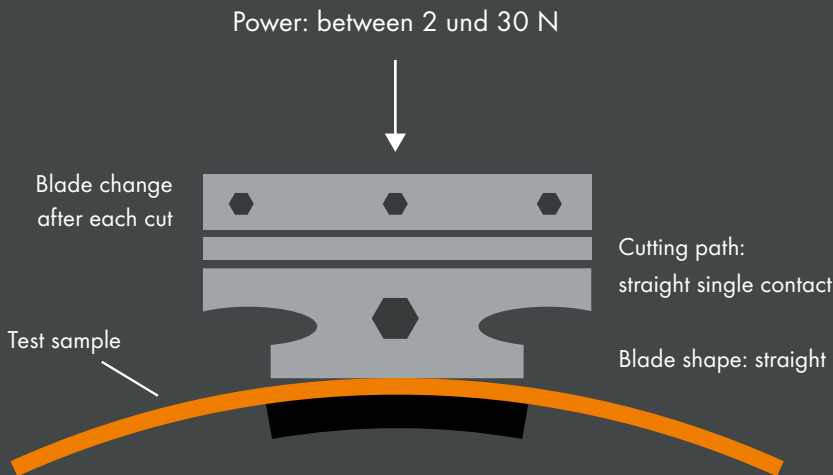

	0	1	2	3	4	5
Abrasion resistance (cycles)	< 100	100	500	2000	8000	–
Cut resistance (factor)	< 1,2	1,2	2,5	5	10	20
Tear resistance (Newton)	< 10	10	25	50	75	–
Puncture resistance (Newton)	< 20	20	60	100	150	–

Level	A	B	C	D	E	F
Cut resistance (Newton)	2	5	10	15	22	30
impact protection	P	If the glove is not shock tested, there is no labeling				

PROTECTION AGAINST MECHANICAL RISKS: EN 388:2016

Protective gloves against mechanical risks bear the pictogram of the standard.

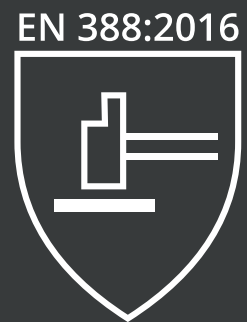

4.X.4.3.C.P

The performance levels of the test must be listed in the following order:

Abrasion resistance (0 - 4)

Cut resistance (0 - 5)

Tear resistance (0 - 4)

Puncture resistance (0 - 4)

Cut resistance (A - F)

Shock protection

Determination of the minimum force with which the test specimen is cut through after 20 millimeters.

NEW CUT LEVEL C MODELS



NIRO-S eco #5018



NIRO-S pro #5019



NIRO-S eco #5020

PROTECTION AGAINST COLD:

EN 511

Protective gloves against cold bear the pictogram of the standard. The performance levels of the test must be listed in the following order:

- Climatic or industrial cold with cold transmission by convection (0 - 4)
- Climatic or industrial cold in case of cold transmission by contact (0 - 4)
- Water permeability (0 oder 1)

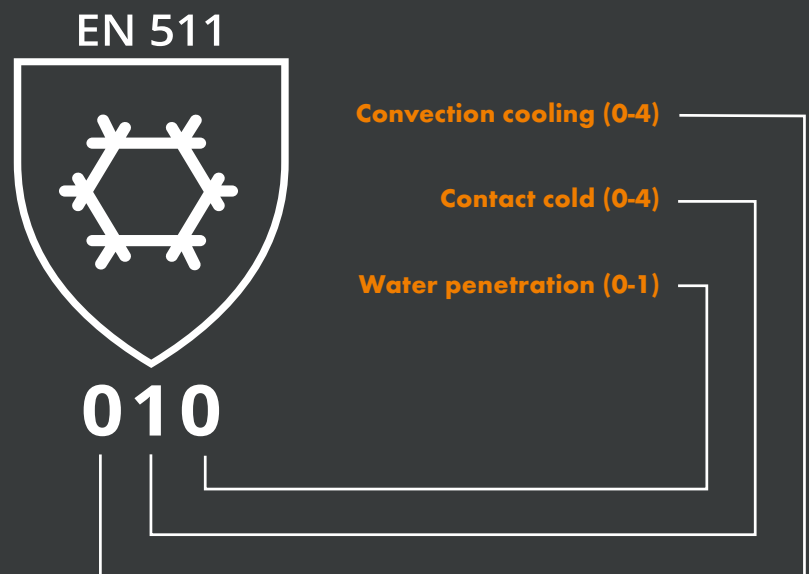

ELECTROSTATIC PROPERTIES EN 16350:2014

The standard DIN EN 16350:2014 deals with electrostatic properties for protective gloves. There is no permissible labeling for ESD gloves.

DIN EN 16350:2014

Test conditions and minimum requirements of electrostatic properties of protective gloves:

- ▶ The contact resistance must be less than 100 megohms ($R_v < 1,0 \times 10^8 \Omega$)
- ▶ The contact resistance R_v is tested according to DIN EN 1149-2:1997
- ▶ The test atmosphere for determining the contact resistance must consist of an air temperature of $23 \pm 1 \text{ }^\circ\text{C}$ and a relative humidity of $25 \pm 5 \%$.
- ▶ Five samples are measured. Each individual measured value must comply with the limit value.

EN 16350:2014



PROTECTION AGAINST THERMAL RISKS (HEAT / FIRE) EN 407:2004

The standard DIN EN 407:2004 deals with the thermal risks for protective gloves, such as contact or radiant heat, flying sparks, fire or liquid metal.

EN 407:2004



A B C D E F

- (A) Flammability (0 - 4)
- (B) Contact heat (0 - 4)
- (C) Convective heat (0 - 4)
- (D) Radiant heat (0 - 4)
- (E) Small droplets of molten metal (0 - 4)
- (F) Large quantities of liquid metal (0 - 4)

**ASSEMBLY GLOVES
MULTIPURPOSE GLOVES**

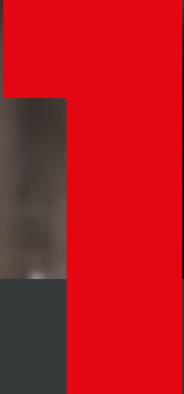



NIRO-S assembly gloves protect hands and products in numerous industrial applications. This protection category (performance level 1/A according to EN388) is intended for general activities.

Depending on your requirements, you will receive the perfect glove for dry, oily or wet work areas. The allrounder among assembly gloves - for operating machines or assembling electronic components and, of course, also for logistics.

**PROTECTION
AND PRECISION
IN EVERYDAY
WORK.**

ASSEMBLY GLOVES

#1010

NIRO-S eco



FEATURES

High dexterity, lint-free, secure grip, and good tactile sensitivity.

RANGE OF APPLICATIONS

Automotive industry, Warehousing and logistics, Manufacturing systems engineering, Painter and decorator, Electrical industry

PRODUCT DETAILS

Palm coated

Main material: Polyester 13 Gauge

Coating: Polyurethane (PU)

Colour: white / white

Sizes: 6, 7, 8, 9, 10, 11

Packaging unit: 12 pairs / 144 pairs in carton

Item number: 3200

#1011

NIRO-S eco



FEATURES

High dexterity, lint-free, secure grip, and good tactile sensitivity.

RANGE OF APPLICATIONS

Automotive industry, Warehousing and logistics, Manufacturing systems engineering, Painter and decorator, Electrical industry

PRODUCT DETAILS

Palm coated

Main material: Polyester 13 Gauge

Coating: Polyurethane (PU)

Colour: grey / grey

Sizes: 6, 7, 8, 9, 10, 11

Packaging unit: 12 pairs / 144 pairs in carton

Item number: 3210

POLYURETHAN COATING

#1012

NIRO-S eco



EN 388:2016
3121X

FEATURES

High dexterity, lint-free, secure grip, and good tactile sensitivity.

RANGE OF APPLICATIONS

Automotive industry, Warehousing and logistics, Manufacturing systems engineering, Painter and decorator, Electrical industry

PRODUCT DETAILS

Palm coated

Main material: Polyester 13 Gauge

Coating: Soft-Polyurethan

Colour: black / black

Sizes: 5, 6, 7, 8, 9, 10, 11

Packaging unit: 12 pairs / 144 pairs in carton

Item number: 3211

#1027

NIRO-S eco



EN 388:2016
3121X

FEATURES

Assembly glove with soft PU coating for a secure grip, good tactile sensitivity, high dexterity and lint-free

RANGE OF APPLICATIONS

Automotive industry, Consumer goods industry, Manufacturing systems engineering, Painter and decorator, Warehousing and logistics

PRODUCT DETAILS

Palm coated

Main material: Polyester 13 Gauge

Coating: Polyurethane (PU)

Colour: blue / black

Sizes: 6, 7, 8, 9, 10, 11

Packaging unit: 12 pairs / 144 pairs in carton

Item number: 3950

ASSEMBLY GLOVES

#1001

NIRO-S pure

#1037

NIRO-S pure



FEATURES

Extremely good sensitivity, high breathability, very high wearing comfort

RANGE OF APPLICATIONS

Automotive industry, Warehousing and logistics, Manufacturing systems engineering, Electrical industry, Aviation

PRODUCT DETAILS

Palm coated

Main material: Nylon 15 Gauge

Coating: Polyurethane (PU)

Colour: red / black

Sizes: 6, 7, 8, 9, 10, 11

Packaging unit: 12 pairs / 144 pairs in carton

Item number: 1280

FEATURES

High breathability, very sensitive, abrasion-resistant, white design allows impurities to be detected more quickly

RANGE OF APPLICATIONS

Automotive industry, Machinery and equipment, Maintenance, Assembly activities, Precision work, Transport, Electrical industry

PRODUCT DETAILS

Palm coated

Main material: Nylon 13 Gauge

Coating: Polyurethane (PU)

Colour: white / white

Sizes: 6, 7, 8, 9, 10, 11

Packaging unit: 12 pairs / 144 pairs in carton

Item number: 4440

#1007

NIRO-S pure



FEATURES

18 gauge liner for excellent tactile feel, high breathability, very high wearing comfort

RANGE OF APPLICATIONS

Electrical industry, Glass industry, Manufacturing systems engineering, Painter and decorator, Warehousing and logistics

PRODUCT DETAILS

Palm coated

Main material: Nylon 18 Gauge

Coating: Polyurethane (PU)

Colour: red / black

Sizes: 6, 7, 8, 9, 10, 11

Packaging unit: 12 pairs / 144 pairs in carton

Item number: 1640

EN 388:2016



3120X

FLEXIBLE AND TOUCH-SENSITIVE

ASSEMBLY GLOVES

#1018

NIRO-S pure



FEATURES

Extremely good wet and dry grip, extremely grippy coating, extremely good tactility

RANGE OF APPLICATIONS

Automotive industry, Aviation, Electrical industry, Manufacturing systems engineering, Paper and cellulose industry

PRODUCT DETAILS

Palm coated

Main material: Nylon 18 Gauge

Coating: Nitrile foam

Colour: blue / black

Sizes: 6, 7, 8, 9, 10, 11

Packaging unit: 12 pairs / 144 pairs in carton

Item number: 3290

#1013

NIRO-S pure



FEATURES

High wearing comfort, increased grip due to extra knobs, very good wet and dry grip

RANGE OF APPLICATIONS

Automotive industry, Building industry, Craft, Manufacturing systems engineering, Warehousing and logistics

PRODUCT DETAILS

Palm coated

Main material: Nylon 15 Gauge

Coating: Nitrile foam with knobs

Colour: red / black

Sizes: 6, 7, 8, 9, 10, 11

Packaging unit: 12 pairs / 144 pairs in carton

Item number: 3240

NITRILE FOAM COATING

#1009

NIRO-S pure



#1021

NIRO-S pure



FEATURES

Thinly applied, water-repellent nitrile foam coating, sensitivity and dexterity, high wearing comfort due to spandex component

RANGE OF APPLICATIONS

Automotive industry, Aviation, Craft, Electrical industry, Manufacturing systems engineering

PRODUCT DETAILS

Palm coated

Main material: Nylon 15 Gauge

Coating: Nitrile foam

Colour: red / black

Sizes: 6, 7, 8, 9, 10, 11

Packaging unit: 12 pairs / 144 pairs in carton

Item number: 3100

FEATURES

Pleasantly soft Sponge-Nitrile foam coating, high wearing comfort due to spandex component, sensitivity and dexterity

RANGE OF APPLICATIONS

Aviation, Glass industry, Manufacturing systems engineering, Painter and decorator, Warehousing and logistics

PRODUCT DETAILS

Palm coated

Main material: Nylon 15 Gauge

Coating: Nitrile foam

Colour: red / grey

Sizes: 6, 7, 8, 9, 10, 11

Packaging unit: 12 pairs / 144 pairs in carton

Item number: 3480

ASSEMBLY GLOVES

#1033

NIRO-S eco



FEATURES

High wearing comfort, increased grip due to extra knobs, very good wet and dry grip

RANGE OF APPLICATIONS

Automotive industry, Building industry, Craft, Manufacturing systems engineering, Warehousing and logistics

PRODUCT DETAILS

Palm coated

Main material: Polyester 13 Gauge

Coating: Micro nitrile foam

Colour: black / black

Sizes: 6, 7, 8, 9, 10, 11

Packaging unit: 12 pairs / 144 pairs in carton

Item number: 4300

#1016

NIRO-S pure



FEATURES

Liquid-tight, very good wet and dry grip, high abrasion resistance

RANGE OF APPLICATIONS

Building industry, Gardening and landscaping, Heavy industry, Painter and decorator, Recycling

PRODUCT DETAILS

fully coated - Nitrile /

Palm and fingertips - Nitrile foam

Main material: Nylon 15 Gauge

Coating: Nitrile / Nitrile foam

Colour: red / black

Sizes: 6, 7, 8, 9, 10, 11

Packaging unit: 12 pairs / 144 pairs in carton

Item number: 3270

#1026

NIRO-S pure



FEATURES

Very good fit with high abrasion resistance, robust and versatile, very good grip on damp and slightly oily surfaces, comfortable wearing sensation

RANGE OF APPLICATIONS

Automotive industry, Building industry, Craft, Manufacturing systems engineering, Warehousing and logistics

PRODUCT DETAILS

Palm coated - Nitrile foam

Main material: Nylon / Spandex 15 Gauge

Coating: Nitrile / Nitrile foam

Colour: grey / black

Sizes: 6, 7, 8, 9, 10, 11, 12

Packaging unit: 12 pairs / 144 pairs in carton

Item number: 3940



OEKO-TEX®
STANDARD 100
TESTED FOR HARMFUL SUBSTANCES

ASSEMBLY GLOVES

#1034

NIRO-S pure



FEATURES

sensitive, flexible fit, high wearing comfort, good grip, finger flexible

RANGE OF APPLICATIONS

Assembly work, Automotive industry, Metal construction, warehouse and logistics, Construction, Maintenance

PRODUCT DETAILS

¾ coated

Main material: Nylon / Spandex 15 Gauge

Coating: Nitrile / Nitrile foam

Colour: grey / black

Sizes: 6, 7, 8, 9, 10, 11, 12

Packaging unit: 12 pairs / 144 pairs in carton

Item number: 4310

#1024

NIRO-S tec



FEATURES

Outstanding fit, oil repellent, very good dry grip, high wearing comfort and OEKO-TEX® Standard 100

RANGE OF APPLICATIONS

Aviation, Craft, Glass industry, Manufacturing systems engineering, Warehousing and logistics

PRODUCT DETAILS

Palm coated

Main material: Nylon 18 Gauge

Coating: NIRO-S TEC

Colour: black / black

Sizes: 6, 7, 8, 9, 10, 11

Packaging unit: 12 pairs / 144 pairs in carton

Item number: 3790

#1029

NIRO-S eco



FEATURES

non-slip, liquid repellent, robust, abrasion resistant / durable

RANGE OF APPLICATIONS

Warehouse and logistics, construction, gardening and landscaping, recycling

PRODUCT DETAILS

Main material: Polyester 13 Gauge

Application: Assembly

Coating: Latex shrink-roughened

Colour: blue / black

Sizes: 6, 7, 8, 9, 10, 11

Packaging unit: 12 pairs / 144 pairs in carton

Item number: 4240



SECURE GRIP IN ANY ENVIRONMENT

LATEX COATING

#1031

NIRO-S eco



FEATURES

High wearing comfort, maximum grip, abrasion-proof / durable, robust, liquid-tight

RANGE OF APPLICATIONS

Automotive industry, Building industry, Craft, Warehousing and logistics, Recycling

PRODUCT DETAILS

Palm coated

Main material: Polyester 13 Gauge

Coating: Latex

Colour: red / black

Sizes: 6, 7, 8, 9, 10, 11

Packaging unit: 12 pairs / 144 pairs in carton

Item number: 4280

#1032

NIRO-S eco



FEATURES

Abrasion-proof / durable, finger movability, liquid repellent, maximum grip, robust

RANGE OF APPLICATIONS

Automotive industry, Building industry, Manufacturing systems engineering, Painter and decorator, Recycling, Warehousing and logistics

PRODUCT DETAILS

Palm coated

Main material: Polyester 13 Gauge

Coating: Latex

Colour: grey / black

Sizes: 6, 7, 8, 9, 10, 11

Packaging unit: 12 pairs / 144 pairs in carton

Item number: 4290

#1036

NIRO-S pure



FEATURES

Abrasion-proof / durable,
flexible fit, liquid-tight,
maximum grip, oil-repellent

RANGE OF APPLICATIONS

Automotive industry, Building
industry, Gardening and
landscaping, Manufacturing
systems engineering, Recycling

PRODUCT DETAILS

Assembling, liquid tight

Main material: Nylon 13 Gauge

Coating: double coated - smooth latex +
sandy latex

Colour: blue / black

Sizes: 6, 7, 8, 9, 10, 11

Packaging unit: 12 pairs / 144 pairs in carton

Item number: 4330

EN 388:2016



3131X

STILVOLL MIT SOFT- BESCHICHTUNG

ASSEMBLY GLOVES

#1019

NIRO-S pure



FEATURES

Liquid-tight on the palms, high grip and slip resistance, as well as good abrasion resistance

RANGE OF APPLICATIONS

Building industry, Gardening and landscaping, Heavy industry, Painter and decorator, Recycling

PRODUCT DETAILS

Palm coated

Main material: Nylon 15 Gauge

Coating: Latex palm crinkled coated

Colour: red / black

Sizes: 6, 7, 8, 9, 10, 11

Packaging unit: 12 pairs / 144 pairs in carton

Item number: 3430

#1014

NIRO-S pure



FEATURES

Extremely lightweight and flexible, very good fit, high abrasion resistance, robust, touchscreen capable

RANGE OF APPLICATIONS

Automotive industry, Building industry, Craft, Gardening and landscaping, Paper and cellulose industry

PRODUCT DETAILS

Palm coated

Main material: Nylon 15 Gauge

Coating: palm microporous latex coated

Colour: red / black

Sizes: 6, 7, 8, 9, 10, 11

Packaging unit: 12 pairs / 144 pairs in carton

Item number: 3250

#1030

NIRO-S eco



FEATURES

non-slip, finger flexible, flexible fit, liquid repellent, high wearing comfort

RANGE OF APPLICATIONS

Automotive industry and suppliers, warehousing and logistics, plant construction and engineering, consumer goods industry

PRODUCT DETAILS

Palm and fingertip

Main material: Polyester 13 Gauge

Application: Assembly

Coating: sandy Latex

Colour: blue / black

Sizes: 6, 7, 8, 9, 10, 11

Packaging unit: 12 pairs / 144 pairs in carton

Item number: 4250



ULTRASOFT AND SUPER GRIP

ASSEMBLY GLOVES

#1008

NIRO-S pure



FEATURES

Liquid-tight, resistant to oils and greases, extremely good dry grip



Protective glove is suitable for food contact

EN 388:2016



4121X

SUPERIOR DRY GRIP

RANGE OF APPLICATIONS

Building industry, Craft, Food industry, Gardening and landscaping, Glass industry, Recycling

PRODUCT DETAILS

Palm coated

Main material: Nylon 10 Gauge

Coating: Nitrile smooth

Colour: red / black

Sizes: 6, 7, 8, 9, 10, 11

Packaging unit: 12 pairs / 144 pairs in carton

Item number: 1700

#1017

NIRO-S eco



FEATURES

High wearing comfort, high mechanical resilience, flexible

RANGE OF APPLICATIONS

Building industry, Gardening and landscaping, Heavy industry, Painter and decorator, Recycling

PRODUCT DETAILS

Palm coated

Main material: Thick cotton liner

Coating: Nitrile

Colour: nature / yellow

Sizes: 6, 7, 8, 9, 10, 11

Packaging unit: 12 pairs / 144 pairs in carton

Item number: 3280

#1022

NIRO-S eco



FEATURES

Liquid-tight, resistant to oils and greases

RANGE OF APPLICATIONS

Automotive industry, Building industry, Gardening and landscaping, Manufacturing, systems engineering, Paper and cellulose industry

PRODUCT DETAILS

Palm coated

Main material: Thin cotton liner

Coating: Nitrile

Colour: nature / yellow

Sizes: 6, 7, 8, 9, 10, 11

Packaging unit: 12 pairs / 144 pairs in carton

Item number: 3481

YOUR PROTECTION AGAINST CUT INJURIES.

NIRO-S cut protection gloves include models with medium, high and maximum cut protection. (from performance level 3/B according to EN388 up to protection class F).

NIRO-S ensures that cut protection gloves are also a pleasure to wear because they are comfortable on the skin even over long periods of time. Find the right model for you.





CUT PROTECTION GLOVES

2

CUT PROTECTION GLOVES

#3006

NIRO-S eco



FEATURES

Lightweight and sensitive, good tactile and fingertip feel, secure grip for dry to slightly damp applications

RANGE OF APPLICATIONS

Automotive industry, Aviation, Heavy industry, Manufacturing systems engineering, Paper and cellulose industry

PRODUCT DETAILS

Palm coated

Main material: HPPE - 15 Gauge

Coating: Polyurethane (PU)

Colour: greying / grey

Sizes: 6, 7, 8, 9, 10, 11

Packaging unit: 12 pairs / 144 pairs in carton

Item number: 3010

EN 388:2016



4342B

DURABLE AND SURE GRIP

CUT PROTECTION CLASS 3/B

#3007

NIRO-S tec



FEATURES

Excellent feel, extremely durable, cut-resistant, lightweight, excellent wearing sensation, OEKO-TEX® Standard 100

RANGE OF APPLICATIONS

Automotive industry, Glass industry, Manufacturing systems engineering, Paper and cellulose industry

PRODUCT DETAILS

Palm coated

Main material: Nylon 18 Gauge

Coating: Nitrile foam

Colour: greying / black

Sizes: 6, 7, 8, 9, 10, 11

Packaging unit: 12 pairs / 144 pairs in carton

Item number: 3750

#3008

NIRO-S plus



FEATURES

Excellent sensitivity, cut-resistant, lightweight with excellent wearing sensation, dermatologically tested

RANGE OF APPLICATIONS

Automotive industry, Aviation, Electrical industry, Glass industry, Manufacturing systems engineering

PRODUCT DETAILS

Palm coated

Main material: Nylon 18 Gauge

Coating: Polyurethane (PU)

Colour: blue / grey

Sizes: 6, 7, 8, 9, 10, 11

Packaging unit: 12 pairs / 144 pairs in carton

Item number: 4010

CUT PROTECTION GLOVES

#3501

NIRO-S ESD



FEATURES

Glove which is antistatic and cut resistant. Also sensitive and touchscreen capable

RANGE OF APPLICATIONS

Automotive industry, Aviation, Electrical industry, Manufacturing systems engineering

PRODUCT DETAILS

Palm coated

Main material: HPPE / Carbon - 13 Gauge

Coating: Polyurethane (PU)

Colour: grey / grey

Sizes: 6, 7, 8, 9, 10, 11

Packaging unit: 12 pairs / 144 pairs in carton

Item number: 4140



CUT PROTECTION CLASS 5/C



CUT PROTECTION GLOVES

#5018

NIRO-S eco

#5019

NIRO-S pro



FEATURES

high wearing comfort, good grip, abrasion resistant / durable, breathable, robust, cut resistant

RANGE OF APPLICATIONS

Automotive industry, Craft, Glass industry, Manufacturing systems engineering, Warehousing and logistics

PRODUCT DETAILS

Coating: Micro nitrile foam

Coating details: palm coated

Main material: UHMWPE 13 Gauge

Colour: green / black

Sizes: 6, 7, 8, 9, 10, 11

Packaging unit: 12 pairs / 144 pairs in carton

Item number: 4200

FEATURES

sensitive, finger flexible, breathable, oil repellent, cut resistant

RANGE OF APPLICATIONS

Automotive industry, Building industry, Glass industry, Manufacturing systems, engineering, Paper and cellulose industry, Warehousing and logistics

PRODUCT DETAILS

Coating: Nitrile foam

Coating details: palm coated / crook of the thumb reinforced

Main material: HPPE - 18 Gauge

Colour: grey / black

Sizes: 6, 7, 8, 9, 10, 11

Packaging unit: 12 pairs / 144 pairs in carton

Item number: 4210

#5020

NIRO-S eco



FEATURES

cut-resistant, robust, abrasion-resistant/durable, oil-repellent, good grip

RANGE OF APPLICATIONS

Glass industry, warehouse and logistics, heavy industry, craft, automotive industry and suppliers

PRODUCT DETAILS

Reinforced palm and fingertips / crook of thumb

Main material: UHMWPE 13 Gauge

Coating: Sandy-Nitrile foam

Colour: green / black

Sizes: 8, 9, 10, 11

Packaging unit: 12 pairs / 72 pairs in carton

Item number: 4230



CUT AND SHOCK RESISTANT

CUT PROTECTION GLOVES



CUT PROTECTION GLOVES 5/D

#5005

NIRO-S eco



FEATURES

Breathable, ergonomic fit, high abrasion resistance

RANGE OF APPLICATIONS

Automotive industry, Aviation, Glass industry, Manufacturing systems engineering, Paper and cellulose industry

PRODUCT DETAILS

Palm coated

Main material: HPPE - 13 Gauge

Coating: Polyurethane (PU)

Colour: grey / grey

Sizes: 6, 7, 8, 9, 10, 11, 12

Packaging unit: 12 pairs / 144 pairs in carton

Item number: 3020

EN 388:2016



4542D

CUT PROTECTION WITH A LOT OF FEELING

CUT PROTECTION GLOVES

#5009

NIRO-S pro

#5016

NIRO-S eco



FEATURES

Good tactile and fingertip sensitivity, ergonomic fit, high abrasion resistance

RANGE OF APPLICATIONS

Automotive industry, Aviation, Building industry, Manufacturing systems engineering, Warehousing and logistics

PRODUCT DETAILS

Palm coated

Main material: HPPE + stainless steel fiber

13 Gauge

Coating: Polyurethane (PU)

Colour: grey / grey

Sizes: 6, 7, 8, 9, 10, 11

Packaging unit: 12 pairs / 144 pairs in carton

Item number: 3820

FEATURES

Protection against blades and sharp edges, flexible fit and high wearing comfort, sensitive, breathable, and durable

RANGE OF APPLICATIONS

Automotive industry, Glass industry, Heavy industry, Manufacturing systems engineering, Paper and cellulose industry, Warehousing and logistics

PRODUCT DETAILS

Palm coated / crook of the thumb reinforced

Main material: HPPE + stainless steel fiber 13 Gauge

Coating: Polyurethane (PU)

Colour: greying / black

Sizes: 6, 7, 8, 9, 10, 11

Packaging unit: 12 pairs / 144 pairs in carton

Item number: 4040

#5015

NIRO-S eco



FEATURES

Good grip features for oily, wet and dry work, cooling effect thanks to HPPE fiber, breathable back of the hand, robust and versatile

RANGE OF APPLICATIONS

Automotive industry, Craft, Gardening and landscaping, Heavy industry, Manufacturing systems engineering

PRODUCT DETAILS

Palm coated

Main material: HPPE - 13 Gauge

Coating: Sandy nitrile foam

Colour: grey / black

Sizes: 6, 7, 8, 9, 10, 11

Packaging unit: 12 pairs / 144 pairs in carton

Item number: 4000

EN 388:2016



4X43F

HIGHEST POSSIBLE CUT PROTECTION!

CUT PROTECTION CLASS F

#5017

NIRO-S pro



FEATURES

Protection from blades and sharp edges, ergonomic fit, good secure grip with high wearing comfort and durable

RANGE OF APPLICATIONS

Automotive industry, Glass industry, Manufacturing systems engineering, Paper and cellulose industry, Recycling

PRODUCT DETAILS

Palm coated / crook of the thumb reinforced

Main material: HPPE + stainless steel fiber
13 Gauge

Coating: Micro nitrile foam

Colour: black / black

Sizes: 6, 7, 8, 9, 10, 11

Packaging unit: 12 pairs / 144 pairs in carton

Item number: 4060



HIGHEST POSSIBLE CUT PROTECTION!

CUT PROTECTION CLASS 5/D

#5008

NIRO-S pro



FEATURES

Protection against blades and sharp edges, abrasion resistant, good secure grip in dry and slightly moist areas

RANGE OF APPLICATIONS

Electrical industry, Glass industry, Manufacturing systems engineering, Paper and cellulose industry, Recycling

PRODUCT DETAILS

3/4 coated

Main material: HPPE + stainless steel fiber
13 Gauge

Coating: Nitrile foam

Colour: grey / black

Sizes: 6, 7, 8, 9, 10, 11

Packaging unit: 12 pairs / 144 pairs in carton

Item number: 3810



HIGHEST POSSIBLE CUT PROTECTION!

CUT PROTECTION GLOVES

#4001

NIRO-S pro



FEATURES

Protection from blades and sharp edges, good finger dexterity and flexibility, high breathability and good abrasion resistance.

RANGE OF APPLICATIONS

Automotive industry, Aviation, Glass industry, Manufacturing systems engineering, Painter and decorator

PRODUCT DETAILS

Main material: Brinix 10 Gauge

Coating: none

Colour: grey

Sizes: 6, 7, 8, 9, 10, 11

Packaging unit: 10 pairs / 100 pairs in carton

Item number: 3870

#5010

NIRO-S pro



FEATURES

Protection against blades and sharp edges, ergonomic fit, good grip in slightly oily and dry areas and good breathability.

RANGE OF APPLICATIONS

Automotive industry, Building industry, Glass industry, Paper and cellulose industry, Warehousing and logistics

PRODUCT DETAILS

Palm with knobs

Main material: Stainless steel fiber 10 Gauge

Coating: Nitrile foam

Colour: mottled blue / black naps

Sizes: 6, 7, 8, 9, 10, 11

Packaging unit: 12 pairs / 144 pairs in carton

Item number: 3880

CUT PROTECTION CLASS F

#5011

NIRO-S pro



FEATURES

Protection from blades and sharp edges, also suitable for rough work, ergonomic fit and good breathability.

RANGE OF APPLICATIONS

Automotive industry, Electrical industry, Glass industry, Heavy industry, Manufacturing systems engineering

PRODUCT DETAILS

Palm reinforced with split leather

Main material: Stainless steel fiber 10 Gauge

Coating: Cow split leather

Colour: mottled blue / grey leather

Sizes: 6, 7, 8, 9, 10, 11

Packaging unit: 12 pairs / 144 pairs in carton

Item number: 3890

#5012

NIRO-S pro



FEATURES

Protection from blades and sharp edges, suitable for rough work, high abrasion resistance, good breathability

RANGE OF APPLICATIONS

Automotive industry, Aviation, Glass industry, Paper and cellulose industry, Recycling

PRODUCT DETAILS

Palm covered

Main material: Stainless steel fiber 10 Gauge

Coating: Cow split leather

Colour: greying / grey leather

Sizes: 6, 7, 8, 9, 10, 11

Packaging unit: 12 pairs / 144 pairs in carton

Item number: 3900

NIRO-S antistatic gloves meet the requirements of the new EN 16350-2014 for protective gloves against electrostatic risks. Gloves with excellent fit and sensitivity.



**ANTISTATIC
PROVIDE
PROTECTION
AGAINST
ELECTROSTATIC
DISCHARGE.**



**ESD GLOVES
ANTISTATIC**



ESD GLOVES

#1501

NIRO-S ESD



FEATURES

Antistatic, sensitive, soft, excellent wearing sensation, good tactile and fingertip feeling

RANGE OF APPLICATIONS

Automotive industry, Aviation, Electrical industry, Manufacturing systems engineering, Painter and decorator

PRODUCT DETAILS

Without coating

Main material: Polyester / Carbon - 15 Gauge

Colour: greying

Sizes: 6, 7, 8, 9, 10, 11

Packaging unit: 12 pairs / 144 pairs in carton

Item number: 3720

#1502

NIRO-S ESD



FEATURES

Antistatic, sensitive, soft, excellent wearing sensation, good tactile and fingertip feeling

RANGE OF APPLICATIONS

Automotive industry, Electrical industry, Manufacturing systems engineering, Paper and cellulose industry, Warehousing and logistics

PRODUCT DETAILS

Fingertips coated

Main material: Polyester / Carbon - 15 Gauge

Coating: Polyurethane (PU)

Colour: greying / white

Sizes: 6, 7, 8, 9, 10, 11

Packaging unit: 12 pairs / 144 pairs in carton

Item number: 3730

#1503

NIRO-S ESD



FEATURES

Antistatic, sensitive, soft, excellent wearing sensation, good tactile and fingertip feeling

RANGE OF APPLICATIONS

Automotive industry, Aviation, Building industry, Electrical industry, Manufacturing systems engineering

PRODUCT DETAILS

Palm coated

Main material: Polyester / Carbon - 15 Gauge

Coating: Soft polyurethane

Colour: greying / grey

Sizes: 6, 7, 8, 9, 10, 11

Packaging unit: 12 pairs / 144 pairs in carton

Item number: 3740

EN 16350:2014

EN 388:2016



3131X

ANTISTATIC WITH PERFECT SHAPE

ESD GLOVES



#1504

NIRO-S ESD



FEATURES

Antistatic, abrasion-resistant, durable, robust and liquid-tight palm

RANGE OF APPLICATIONS

Aviation, Electrical industry, Manufacturing systems engineering, Warehousing and logistics

PRODUCT DETAILS

Palm coated

Main material: Polyester / Carbon - 15 Gauge

Coating: Nitrile

Colour: grey / black

Sizes: 6, 7, 8, 9, 10, 11

Packaging unit: 12 pairs / 144 pairs in carton

Item number: 4130

ANTISTATIC WITH CUT PROTECTION CLASS 5/C

#3501

NIRO-S ESD



FEATURES

Glove which is antistatic and cut resistant. Furthermore sensitive and touchscreen capable

RANGE OF APPLICATIONS

Automotive industry, Aviation, Electrical industry, Manufacturing systems engineering

PRODUCT DETAILS

Palm coated

Main material: HPPE / Carbon - 13 Gauge

Coating: Polyurethane (PU)

Colour: grey / grey

Sizes: 6, 7, 8, 9, 10, 11

Packaging unit: 12 pairs / 144 pairs in carton

Item number: 4140



3542C

ANTISTATIC WITH CUT PROTECTION

NIRO-S winter gloves are based on the EN 511 standard, which applies to gloves that are resistant to convection cooling and contact cold and are also waterproof.

Our gloves keep the wearer's hands warm and comfortable even in icy temperatures.



**THE OPTIMAL
PROTECTION IN
COLD AND ICE.**

4

WINTER GLOVES
COLD PROTECTION



niro plus
#3005
LEVEL 2 **SIZE 08**
www.niro-s.de

WINTER GLOVES

#1020

NIRO-S pure



FEATURES

Cold protection, back of the hand water repellent, coating against liquids

RANGE OF APPLICATIONS

Building industry, Craft, Heavy industry, Recycling, Warehousing and logistics

PRODUCT DETAILS

Palm coated

Main material: Terry - 10 Gauge brushed inside

Coating: Sandy latex foam

Colour: red / grey

Sizes: 6, 7, 8, 9, 10, 11

Packaging unit: 12 pairs / 144 pairs in carton

Item number: 3460

EN 388:2016



2131X

EN 511



010

THE WINTER GLOVE

#3005

NIRO-S plus



FEATURES

Cold protection, water repellent, high abrasion resistance and good grip

RANGE OF APPLICATIONS

Automotive industry, Craft, Gardening and landscaping, Heavy industry, Warehousing and logistics

PRODUCT DETAILS

3/4 coated

Main material: Terry - 10 Gauge brushed

Coating: Sandy nitrile foam

Colour: yellow / black

Sizes: 6, 7, 8, 9, 10, 11

Packaging unit: 12 pairs / 144 pairs in carton

Item number: 3470

EN 388:2016



4221X

EN 511



020

**EVERYTHING
UNDER CONTROL
EVEN WITH ICE**

WINTER GLOVES

#1028

NIRO-S ice



FEATURES

high wearing comfort, good grip,
abrasion resistant / durable,
oil repellent, cold repellent

RANGE OF APPLICATIONS

Building industry, Craft,
Gardening and landscaping,
Recycling, Warehousing and
logistics

PRODUCT DETAILS

Palm coated

Coating: Latex

7 G Polyester-Terry

Colour: yellow / black

Sizes: 8, 9, 10, 11

Packaging unit: 12 pairs / 144 pairs in carton

Item number: 4220

EN 388:2016



4142X

EN 511



X2X

EN 407:2004



COLD REPELLENT

#2001

NIRO-S ice



FEATURES

high wearing comfort, good grip, abrasion resistant / durable, liquid repellent, cold repellent, heat repellent

RANGE OF APPLICATIONS

Automotive industry, Building industry, Consumer goods industry, Gardening and landscaping, Recycling, Warehousing and logistics

PRODUCT DETAILS

full coated smooth latex / palm coated sandy latex

Coating: double coated - smooth latex + sandy latex, Sandy latex foam

Colour: orange / black

Sizes: 6, 7, 8, 9, 10, 11

Packaging unit: 12 pairs / 72 pairs in carton

Item number: 4190

EN 388:2016



2232B

EN 511



X2X

EN 407:2004



LIQUID TIGHT

When handling sheet metal, plastics and glass, NIRO-S arm sleeves in various versions and lengths protect against cuts, abrasions and burns. Innovative yarns ensure outstanding wearing comfort.

**PROTECTIVE SLEEVES
EXCLUSIVE CUFF EDITION**



ARM PROTECTION AGAINST HEAT AND CUTS.



PROTECTIVE SLEEVES

#4501

NIRO-S cuff



FEATURES

Protection against sharp edges, ergonomic fit, good breathability, contact heat resistant up to 100° C

RANGE OF APPLICATIONS

Automotive industry, Heavy industry, Manufacturing systems engineering, Paper and cellulose industry, Warehousing and logistics

PRODUCT DETAILS

Main material: Paraamid / Nylon

Without coating

Colour: green

Sizes: 30, 35, 40, 45, 50

Packaging unit: 10 pieces / 100 pieces in carton

Item number: 3910

#4502

NIRO-S cuff



FEATURES

Protection against sharp edges, ergonomic fit, good breathability, Velcro closure against slipping.

RANGE OF APPLICATIONS

Aviation, Glass industry, Manufacturing systems engineering, Paper and cellulose industry, Warehousing and logistics

PRODUCT DETAILS

Main material: Polyethylene-Polyester-Fiber-Polyamid
13 Gauge

Without coating

Colour: greying / 3-finger opening

Sizes: 30, 35, 40, 45, 50

Packaging unit: 10 pieces / 100 pieces in carton

Item number: 3920

#5501

NIRO-S cuff



EN 388:2016



2542C

EN 407:2004



X1XXXXX

FEATURES

Protection against sharp edges, ergonomic fit, good breathability, contact heat resistant up to 100 °C

RANGE OF APPLICATIONS

Automotive industry, Aviation, Glass industry, Manufacturing systems engineering, Warehousing and logistics

PRODUCT DETAILS

Main material: Polyethylene-Polyester-Fiber-Polyamid
13 Gauge

Without coating

Colour: yellow

Sizes: 30, 35, 40, 45, 50

Packaging unit: 10 pieces / 100 pieces in carton

Item number: 3930



SERVICE

Top service and direct contact with our customers are particularly important to us. If you have any questions, suggestions or requests, please do not hesitate to write us a short message or simply give us a call.

Telephone: +49 (0) 7041 9544-0

Telefax: +49 (0) 7041 9544-55

E-Mail: info@niro-s.de

Web: www.niro-s.de/en



GLOVES BY EXPERTS



Friedrich **M**ünch
GmbH + Co KG

FRIEDRICH MÜNCH GMBH + CO KG

In den Waldäckern 10 75417 Mühlacker - Germany

Tel: +49 7041 9544-0 | Fax: +49 7041 9544-55

E-Mail: info@niro-s.de | Web: www.niro-s.de